

**INSTALLING VANITY WITH TWO PEOPLE IS HIGHLY RECOMMENDED**

**BOX CONTENTS**

- Ceramic Basin
- Vanity Base Cabinet

**MAIN BODY PARTS**

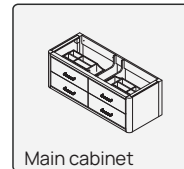
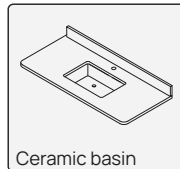

**MAIN CABINET INSTALLATION INSTRUCTIONS**

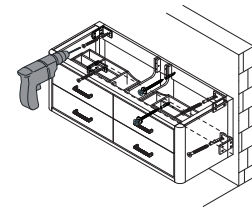
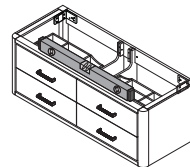

1. Secure the main cabinet



After still for 24 hours

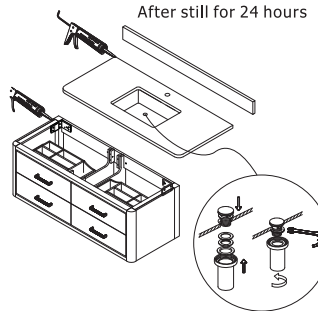

\*Does not include faucet, drain assembly, or P-trap

2. Paste the countertop

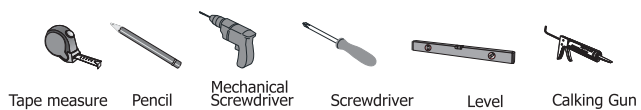

**INSTALLATION TIPS**

- Add silicone to attach frame
- Secure the countertop to the main cabinet

**RECOMMENDED TOOLS**

Tape measure

Pencil

Screwdriver

Level

Calking & Calking Gun

• Please check your product packaging to make sure the included accessories, etc.

**INSTALLATION INSTRUCTION**

Removal of side rail with front connector

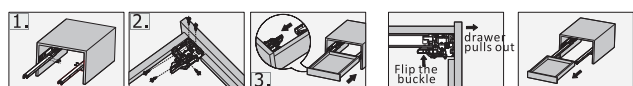

Flip the buckle of the front connector, then pull the drawer out to complete the disassembly

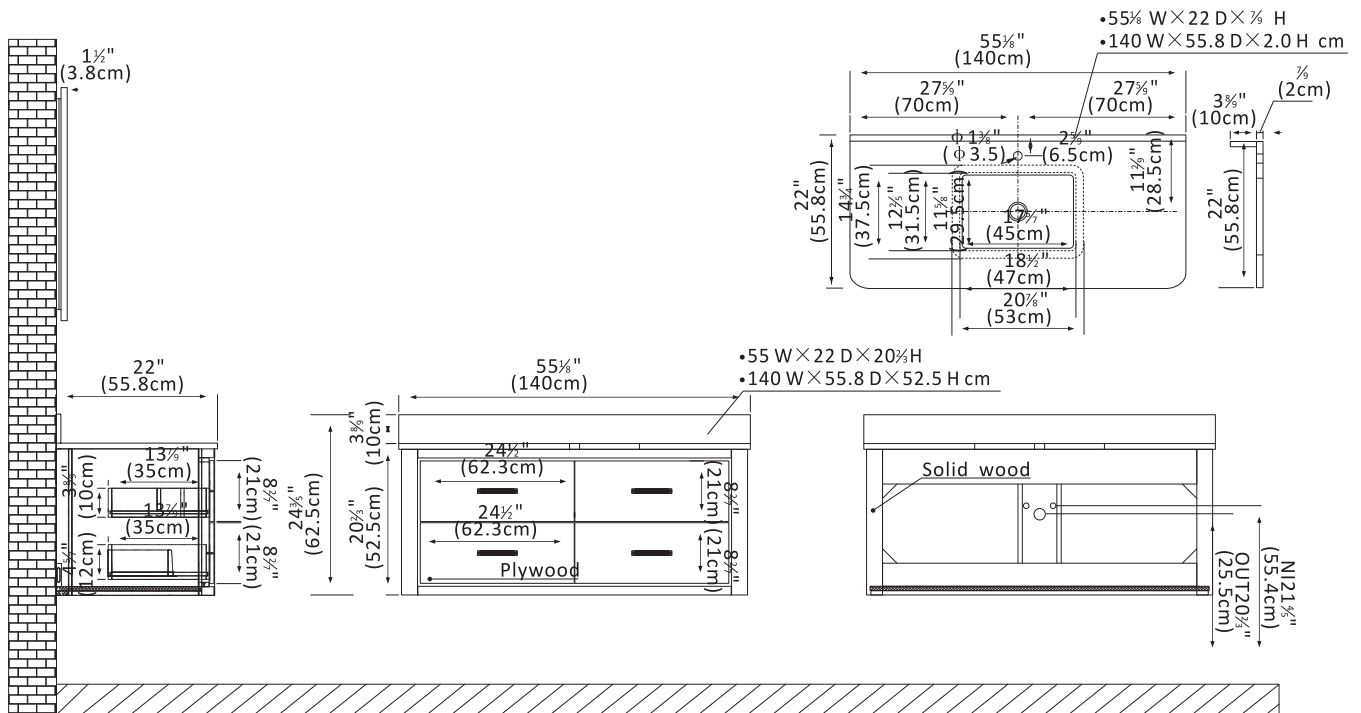

**VANITY CARE GUIDE**

**Vanity Care**

- Avoid direct contact of sharp objects as they can cause exterior damage.
- Do not expose directly to the sun as it can cause aging and cosmetic damage.
- Avoid placing hot objects onto the vanity surface.

**Countertop Care**

- Kindly note that all our tops are sealed before shipping but may stain, scratch or chip because they are porous by nature.
- Do not place hot items directly on the countertop as it can damage it.
- To prevent ring marks or staining, dry immediately.
- Place table mats beneath objects that can potentially scratch the surface.
- Occasionally wash with a cloth dampened with warm water. If needed, apply a small amount of mild dishwashing liquid or soap to clean. Dry with a soft cloth.
- Refrain from using chemical cleaners, sprays, abrasive cleaners, or products that contain lemon, vinegar, or other acids.
- We advise to reseal top annually or when necessary.

**Cleaning and maintenance**

- Avoid using cleaning products that contain Bleach or Ammonia.
- Please use wood-friendly products on wooden base vanities.
- To adequately clean exterior surfaces, use natural cleaning solutions or soap.

**⚠ WARNING**

This product can expose you to chemicals including Nickel compounds, which is known to the State of California to cause cancer. For more information visit [www. P65Warning. ca. gov](http://www.P65Warning.ca.gov)

**⚠ WARNING**

This product can expose you to Glass wool fibers (inhalable and biopersistent), which is known to the State Of California to cause cancer. For more information, go to [www. P65Warnings. ca. gov](http://www. P65Warnings. ca. gov)

**⚠ WARNING**

Serious or fatal crushing can occur from furniture tip over . To prevent tip over this furniture must be used with the wall attachment device(s) provided.

Screw(s) and plug(s) for the wall are not included. Use screw(s) and plug(s) suitable for your walls. If you are uncertain, seek professional Advice. Read and follow each step of the instruction carefully.