

INSTALLATION GUIDE BUNGALOW 36"

Before beginning to assemble and install your vanity, please check that you have received all of the parts and hardware listed in the packing list. Please report any missing items immediately.

To avoid scratches, scuffs, and other damage, do not assemble your vanity directly on the floor. Place a sheet of cardboard or another protective surface on the floor, and assemble your vanity on top of it. Always protect all surfaces from sharp objects, high heat sources, direct prolonged sunlight, and harsh chemicals.

Professional installation is recommended.

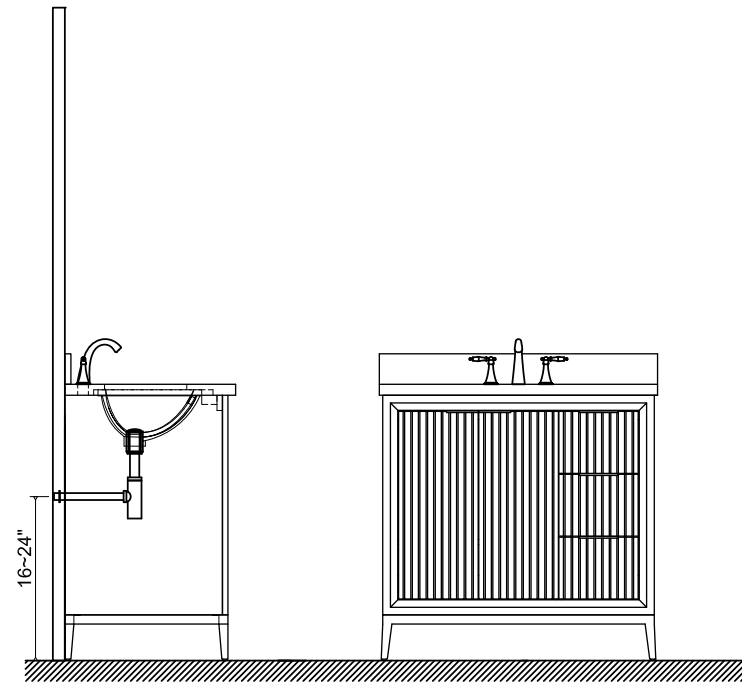

PACKING LIST

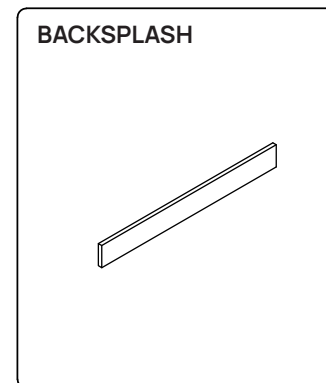
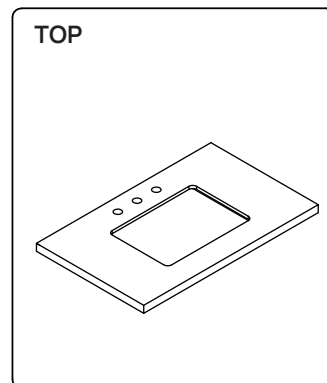
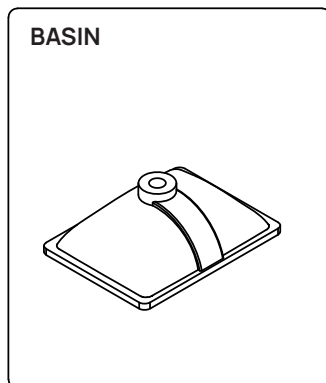
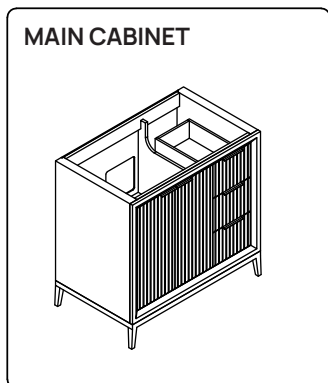

REQUIRED TOOLS

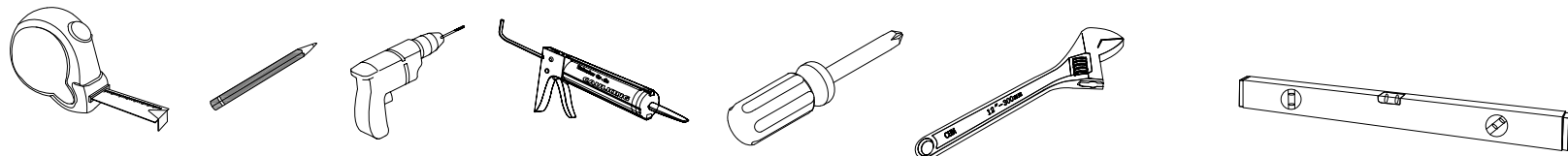

STEP 1

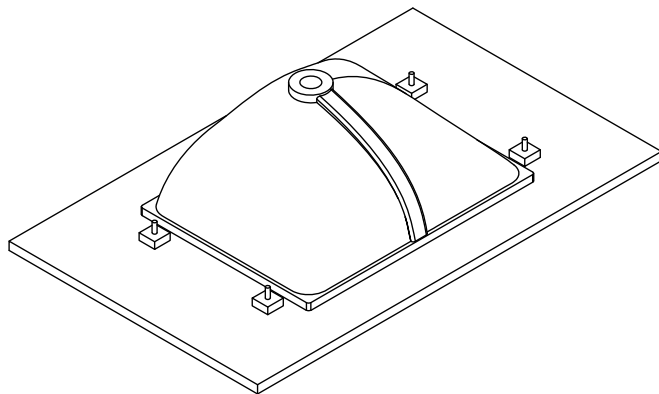

Set the countertop upside-down on a soft surface and place the basin upside-down on the countertop.

STEP 2

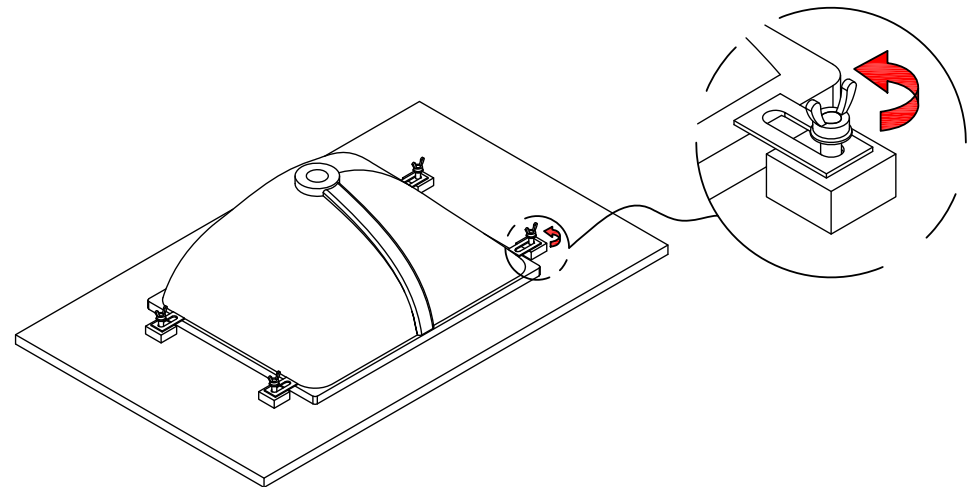

Place and tighten the screws in the aligned holes.

STEP 3

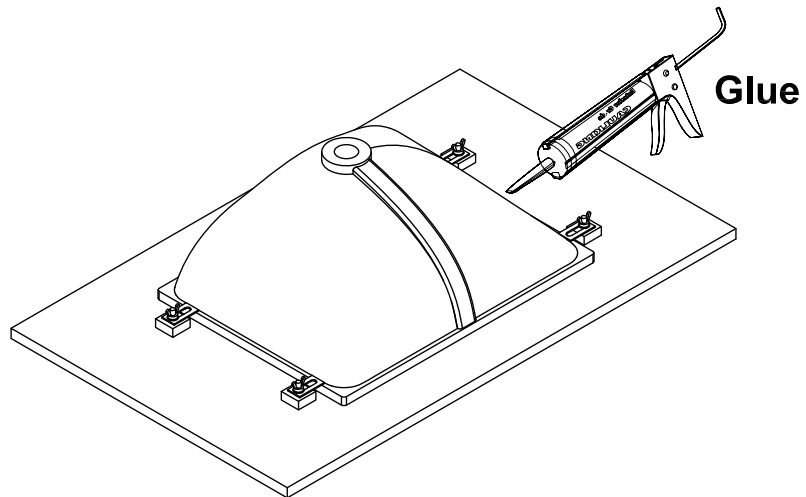

Apply caulk around the perimeter where the basin meets the countertop. Wait 24 hours for the caulk to dry fully.

STEP 4

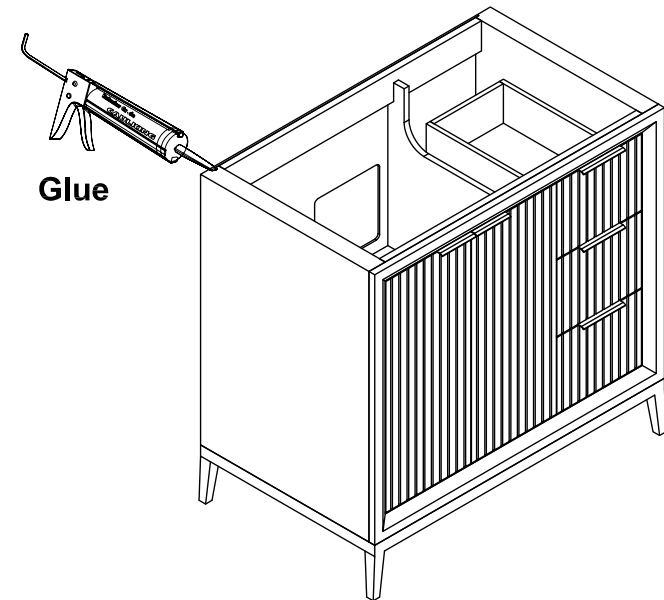

Apply caulk around the perimeter of the top of the cabinet.

STEP 5

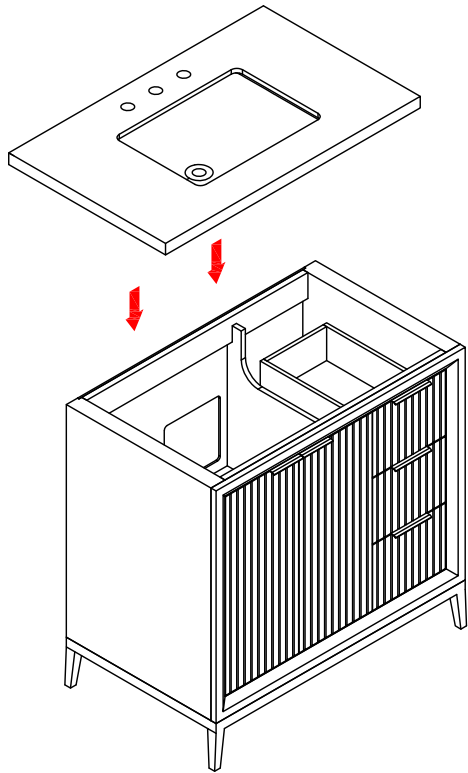

Install the countertop and attached basin so that the rim of the countertop rests on the caulk.

STEP 6

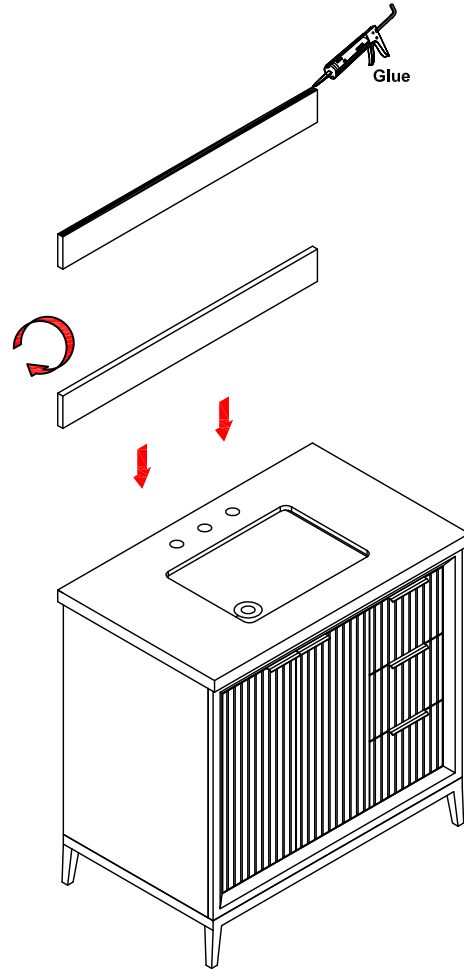

Apply caulk to the bottom of the backsplash and install so that the edge is flush with the back of the countertop.

STEP 7

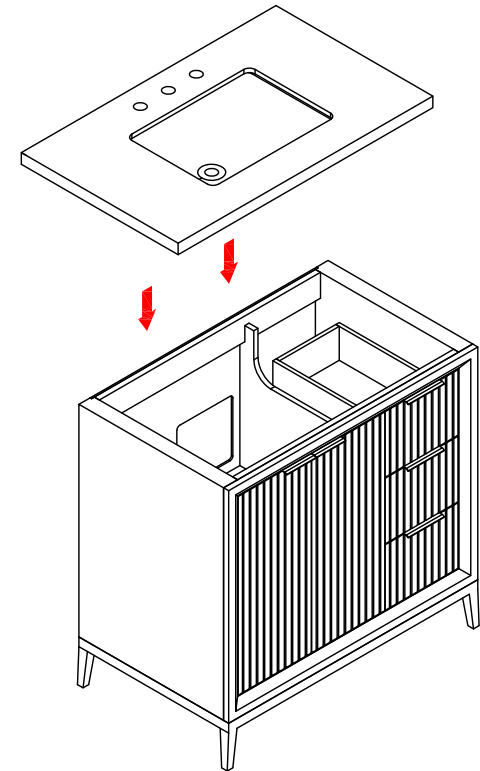

Please allow the caulk to dry for at least 24 hours before using your vanity.