

IMPORTANT SAFETY INSTRUCTIONS

When using an electrical furnishing, basic precautions should always be followed, including the following:

**DANGER**

READ AND FOLLOW ALL INSTRUCTIONS BEFORE USING THIS MIRROR.

**WARNING**

To reduce the risk of burns, fire, electric shock or injury to persons. Use this furnishing only for its intended use as described in these instructions. Do not use attachments not recommended by the manufacturer. Never drop or insert any object into any opening. Do not use outdoors.

**WARNING**

Risk of electric shock. Connect this furnishing to a properly grounded circuit only. See Grounding instructions.

GROUNDING INSTRUCTIONS:

This product must be connected to a grounded metal, permanent wiring system, or an equipment-grounding conductor must be run with the circuit conductors and connected to the equipment-grounding terminal or lead on the product.

**WARNING**

An Electrical option cabinet must be wired to a 20 Amp GFI (Ground Fault Interrupter) protected circuit when used in bathrooms and all other locations required by the National Electric Code.

PLEASE SAVE THESE INSTRUCTIONS FOR FUTURE REFERENCE

TOOLS REQUIRED FOR ASSEMBLY

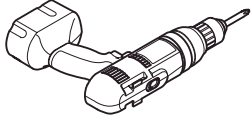

Electrical Drill



1/8" Drill Bit

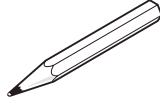

Pencil



Phillips
Screwdriver



Tape Measure

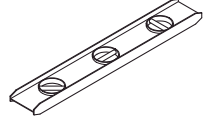

Level

PARTS INCLUDED

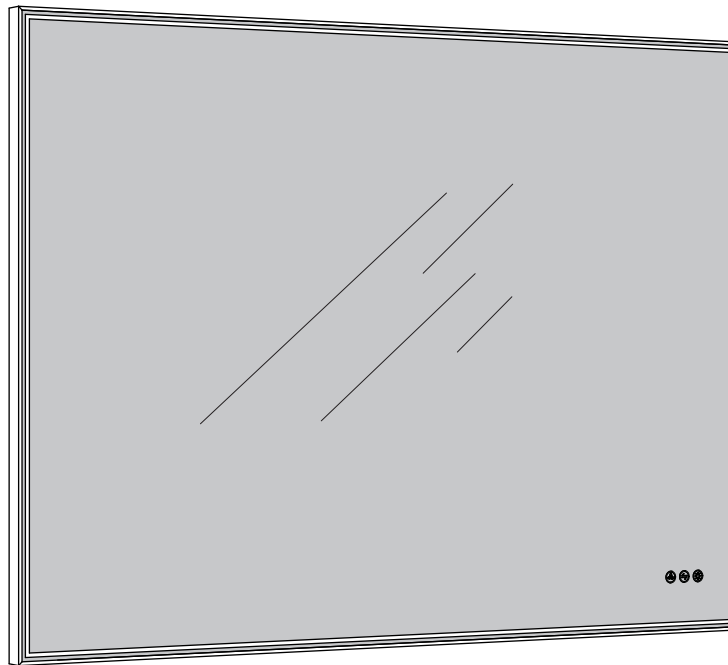

Mirror

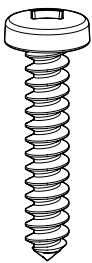

SCREW
(x2)

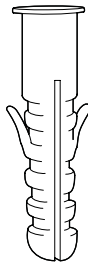

WALL PLUG
(x2)

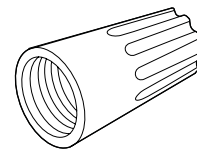

WIRE CONNECTOR
(x2)



NOTE: Determine overall mirror dimensions before proceeding to installation.

*All dimensions & specifications are approximate and subject to change without notice.

ELECTRIC CONNECTIONS

ALL WIRING SHOULD BE DONE BY A QUALIFIED LICENCED ELECTRICIAN



WARNING: Shut off power before wiring the mirror.



WARNING: An Electrical option mirror must be wired to a 20 Amp GFI (Ground Fault Interrupter) protected circuit when used in bathrooms and all other locations required by the National Electric Code.



WARNING: This mirror must be connected to a grounded, metal permanent wiring system or an equipment-grounding conductor must be run with the circuit conductors and connected to the equipment grounding terminal or lead on the mirror.



CAUTION: Requires 120 VAC 20 Amp GFI protected circuit.

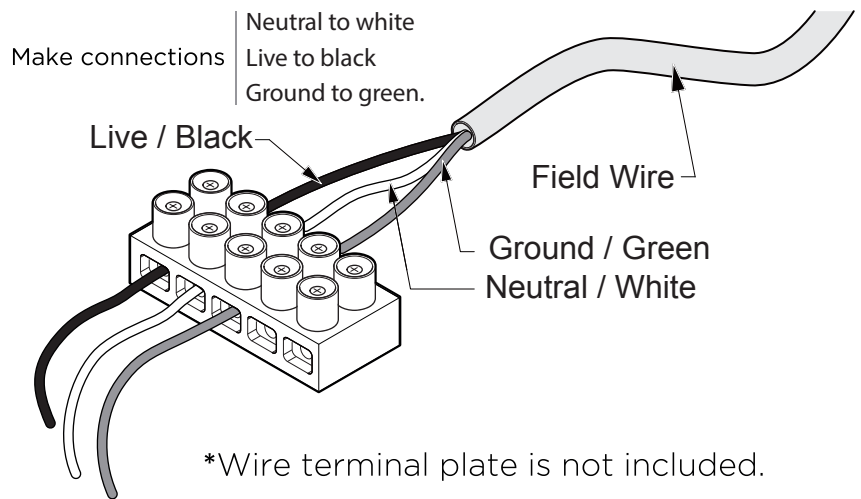
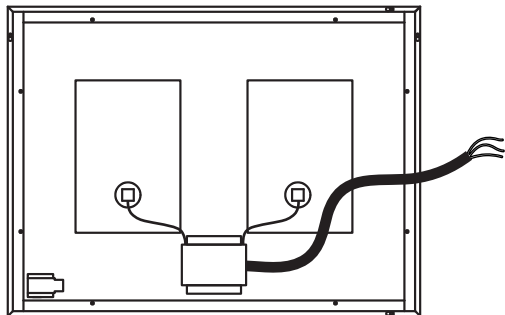

Electric wiring: Be sure to provide enough wire to make the proper and safe connection to the Field/Power.

MIRROR FEATURES

- 4mm copper free silver mirror
- High output LED lighting:
CRI 90+, 2700-6400K CCT, IP44
- Colour changing and dimmable touch switch for surface LED
- Vertical and horizontal mount options
- Defogger

INSTALLATION INSTRUCTIONS

1 PLACEMENT

Select the desired position of the mirror.
Level and mark the location.

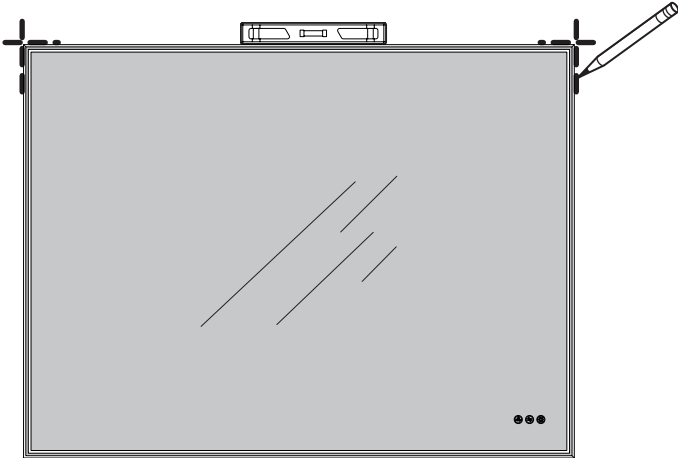

2

SUPPORT LOCATION

Measure the center of the holes and mark the drilling locations ensure marking are leveled.

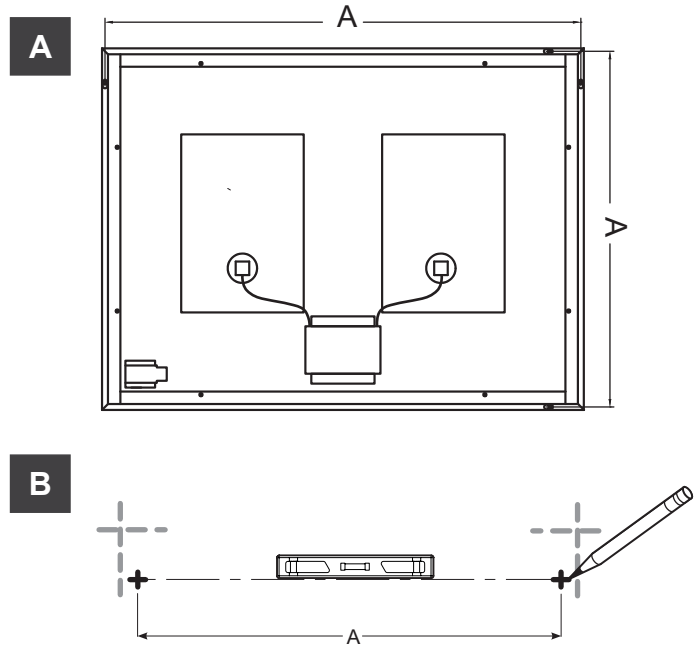

3 INSTALL SCREWS

Using a drill, make holes and fill with supplied plugs and screws. Leave a gap of 2 - 3mm between the head of the screw and the wall.

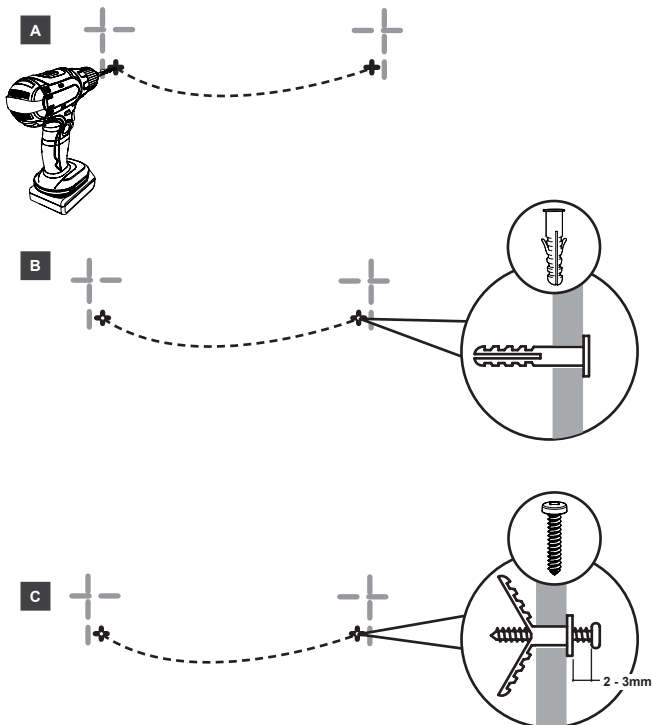

4

PLACEMENT

Place the mirror against the wall and slide down as shown in image B.

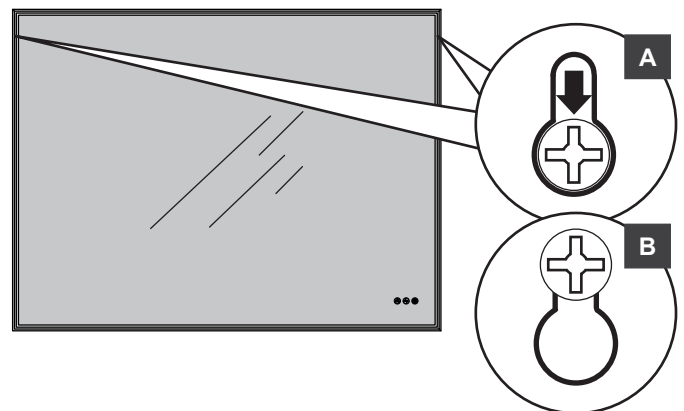

FINAL ASSEMBLY**How to use Defogger Switch and Dimmer Switch:**

Touch  to turn the task light and defogger on or off.

Press and hold  to change the colour temprature of task light.

Press and hold  to dim or brighten the task light.

Use and Maintenance:**CAUTION:**

Mirror and mirror's body are constructed of mirrored glass and aluminum. Use a damp cloth to clean your mirrors. Do not use any abrasive material as it may damage the surface and finish of the mirror. A mild detergent may be used to clean the surfaces of the mirror. When cleaning spray the cloth, not the mirrors or surrounding surfaces.