

INSTALLATION GUIDE

Oriel 30"



Read all instructions before unpacking the product. During unpacking the product and prior to installation inspect your new product for any damages or missing parts. Do not attempt to install or operate the product if the product is damaged.

To avoid scratches, scuffs, and other damages, do not assemble your vanity directly on the floor. Place a sheet of cardboard or another protective surface on the floor, and assemble your vanity on top of it. Always protect all surfaces from sharp objects, high heat sources, direct prolonged sunlight, and harsh chemicals.

Professional installation is recommended.

REQUIRED TOOLS

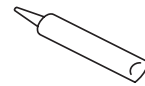

Silicone



Safety Glass

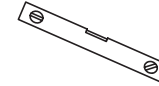

Level

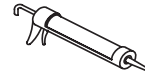

Silicone/
Caulk Gun

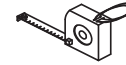

Tape
Measure



Soft Cloth
or Blanket

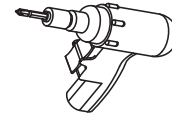

Drill



Drill Bit



Pencil/Marker

SUPPLIED PARTS

PART A		6 PIECES
PART B		6 PIECES
PART C		6 PIECES

STEP 1

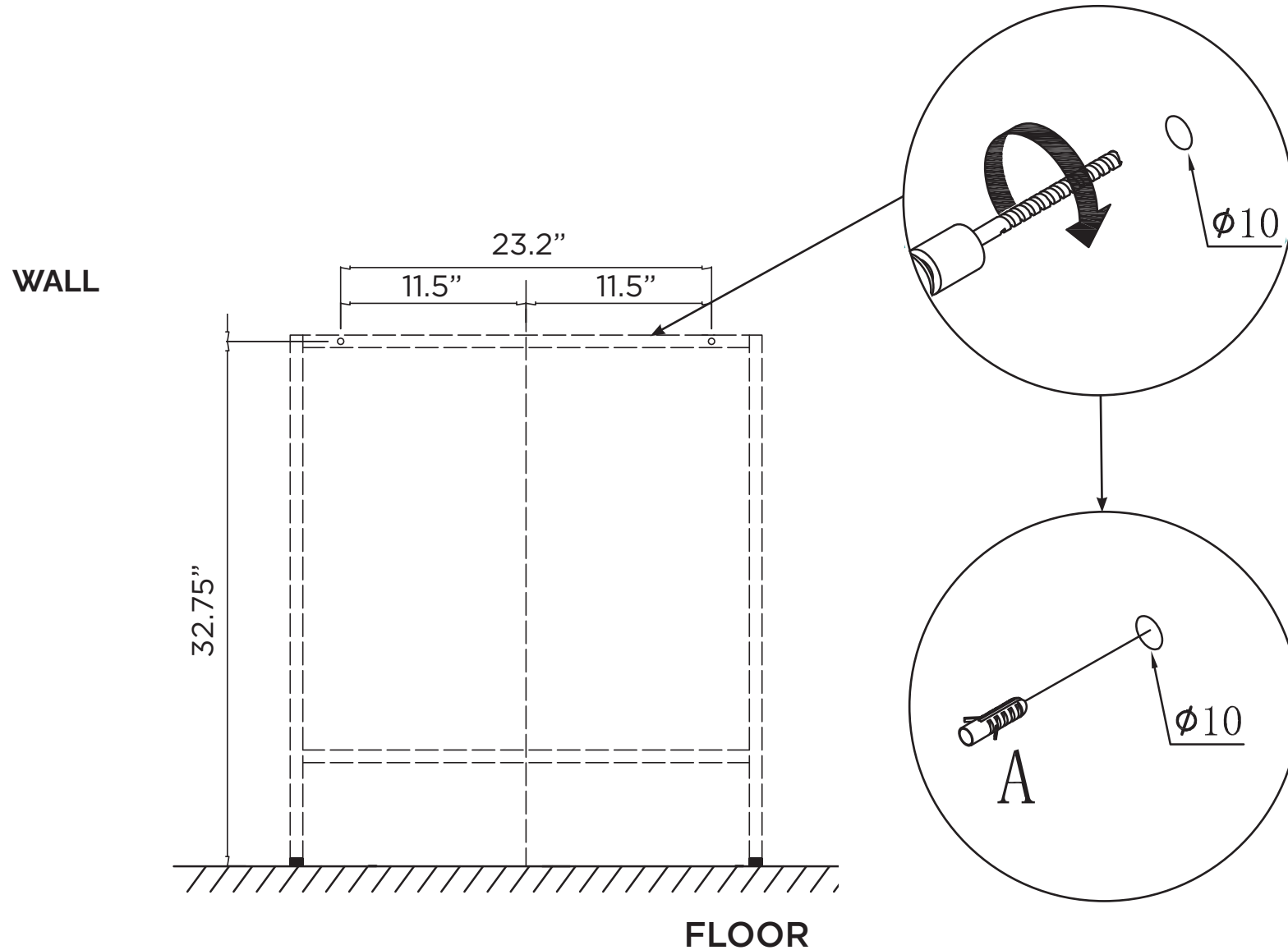

Dimensions may vary by up to 3/8". It is highly recommended to pull all dimensions of actual model for installation and measuring purposes.

INSTALLATION GUIDE

Oriel 30"

tilebar

STEP 2

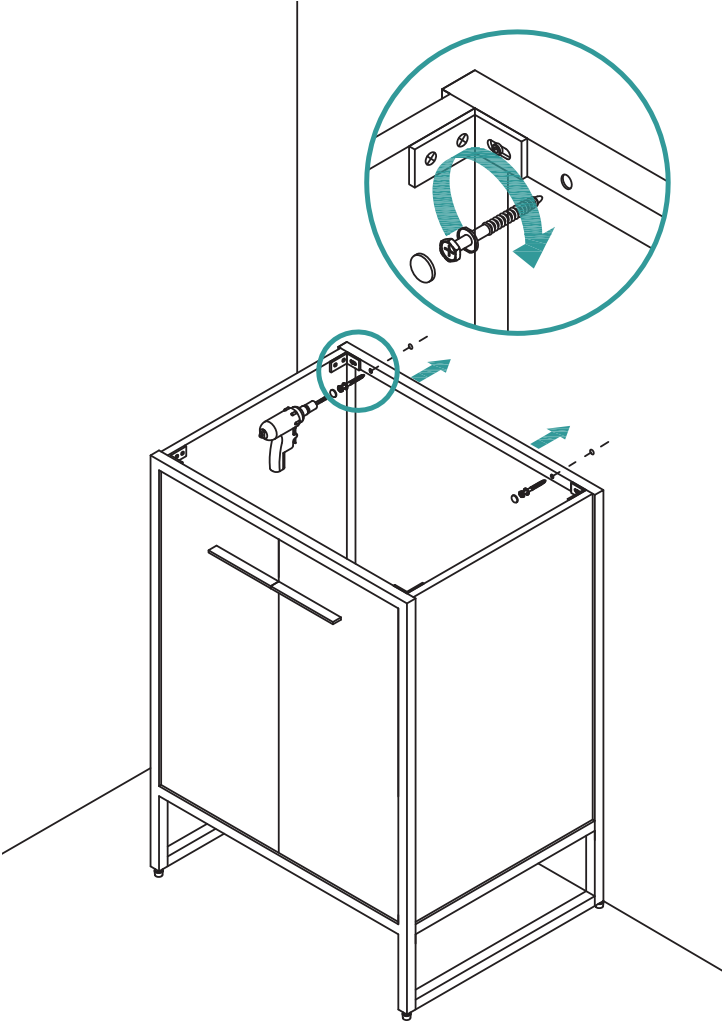

STEP 3

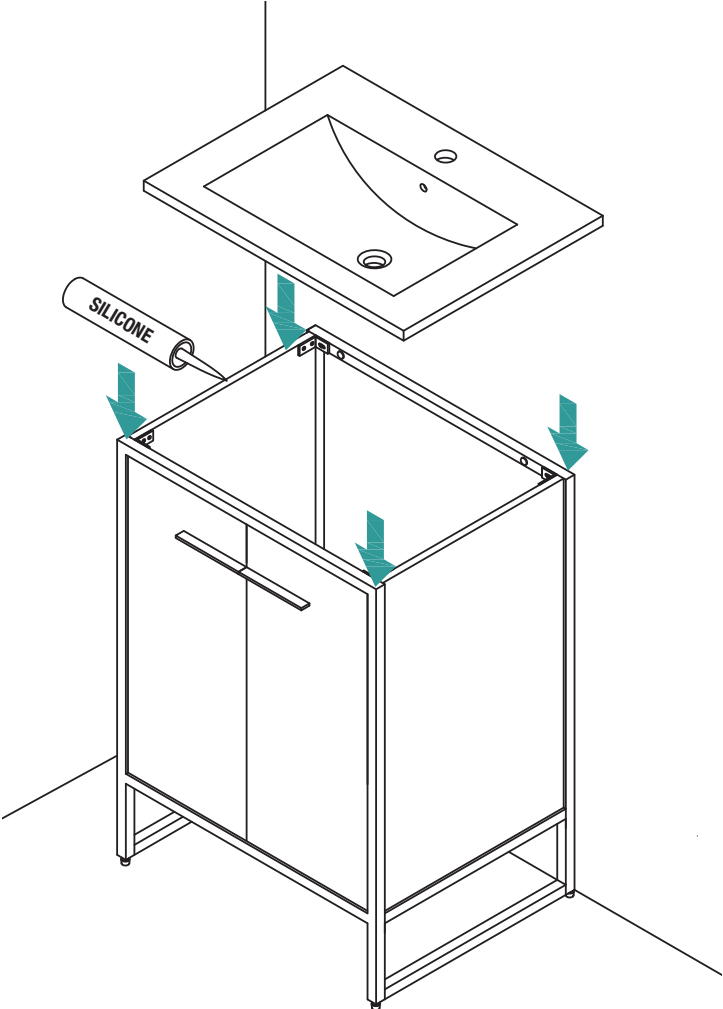

STEP 4

